

# Nylon Cable Tie / Wire Accessories

尼龍紮線帶/配線器材



志信塑膠股份有限公司  
JYH SHINN PLASTIC CO., LTD

## Company Profile / 公司簡介

---

JYH SHINN PLASTIC (TIE PRO-Taiwan) has been found since 1976, and specialized in production of Nylon Cable Tie and Wiring Accessories. We have professional technology in Plastic Injection Model developing & modeling experiences to meet the demand of the special requirement from the customers.

Since the establishment, we continue to supply our customers with high quality, on-Time delivery and customer satisfaction. We devote to upgrade our product's quality, we adopt automatic equipment for production line and shorten the time of delivery. In 1993, all of our production lines have been approved by UL certificate. In 2005, our products are complied with the European Union's RoHS standards and are tested and certified for compliance by SGS Taiwan Co., Ltd. By doing this, we affirm our top quality to return to our clients.

At present, the sales area of our products is spreading all over the world, including Europe, USA, Asia and Japan, etc. Oversea branch are under programming and development to strive for the near future. Future, we will continue to develop new products and offer swift and best service to customers and gain the best satisfaction from being our customers.

志信塑膠股份有限公司(束帶專家)於1976年創立迄今，專業於尼龍束帶及配線器材之製造與開發已有40多年的時間，俱備塑膠模具的設計及射出塑成形的經驗，可配合客戶的特殊需求進行產品開發。

自創立以來，我們一直持續不斷追求品質至上、精益求精、交期準確、顧客滿意為宗旨。致力於各方面品質之提升，採用自動化設備生產以增加產量、縮短交期。於1993年主力產品全面通過UL安規認證，自2005年產品亦全面導入歐盟RoHS規範並通過SGS認證，更加肯定我們在品質提升上所做的努力。

目前我司產品銷售於國內及歐、美、日等地區，海外據點的成立將是我們規劃及努力中的方向。未來，我們將以不斷開發新產品及提供更快、更優質的服務給客戶，並期許得獲得您最滿意的青睞。



## Index / 索引

---

### **Cable Ties / 束帶類**

Nylon Cable Tie / 尼龍束帶	01
Heavy Duty & Heat-Stablized Cable Tie / 寬型強力束帶&耐熱束帶	02
Releasable Cable Tie / 可退式束帶	03
Marker Tie / 標示牌束帶	04
Velcro Cable Tie (Releasable) / 粘扣式束帶 / 粘扣帶	05
Locking / Mounting Cable Tie / 鎖孔式束帶	06
TEFZEL Cable Tie / 鐵氟龍束帶	07
Acid & Alkali Cable Tie / 耐酸鹼束帶	07
Security Tie / 保密束帶	08
Printed Cable Ties / 印刷束帶	08
Stainless Steel Cable Tie (With Ball Lock) / 珠式不銹鋼束帶	09
Stainless Steel Cable Tie (Ladder Type) / 梯型不銹鋼束帶	10
Stainless Steel Cable Tie (Releasable Type) / 可退式不銹鋼束帶	11

### **Wire Accessories / 配線器材類**

Wire Tie Mount & Cable Clamp / 電線固定座 & 固定鈕(夾)	12
Metal Cable Clamp / 金屬固定鈕	13
Wire Duct (Slot / Solid) / 配線槽	14
Wire Duct (Close / Solid) / 配線槽(封軌型)	15
Round Type Wire Duct / 半圓形地板配線槽	16
Telephone & Decoration Wire Duct / 電話&防盜壓條	17
Spiral Wrapping Band / 捲式結束帶	18
General Purpose, Heat Shrinkable Tubing / 環保熱縮套管	19
Nylon Cable Glands / 尼龍電纜固定頭	20
Flexible Conduit (PP/Nylon) / 浪管	21

### **Terminals & Connectors / 端子 & 接頭類**

Close-End Connector / 閉端端子	22
Screw-On Wire Nut / 彈簧螺式接頭	23
Insulated Cord End Terminals / 歐式端子	24
Splicing Connector / 快速接續子	25
Quick Splicing / 接線夾	25

### **Tools / 束帶工具類**

Nylon Cable Tie Gun (Auto. Cut-off) / 尼龍束帶專用槍	26
Nylon Cable Tie Gun / 尼龍束帶專用槍	26
S. S Cable Tie Gun (Auto. Cut-off) / 全自動不銹鋼束帶專用槍	26
S. S Cable Tie Gun / 半自動不銹鋼束帶專用槍	26

# Nylon Cable Tie / 尼龍束帶

PRODUCTS DESCRIPTION		產品描述	
MATERIAL	UL Approved Nylon (PA) 6/6	材質	採用UL合格之Nylon 6/6製成，防火等級94-V2，耐酸鹼，不易老化，承受力強
COLOR	Natural Or Black, Other Special Color, Heat Stabilized & Weather Resistance Material is Also Available		
FLAME-RETARDANT	UL 94-V2	顏色	標準色為尼龍本色(白色)或黑色；另外也接受訂製特殊顏色、抗UV及耐高溫等材質
TEMPERATURE RANGE	Max. 85 °C (Standard)	操作溫度	最高達85 °C (標準型)

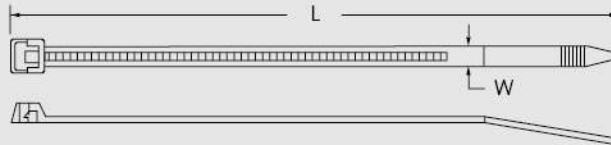

## PRODUCTS SPECIFICATION 產品規格

型號 ITEM NO.	長度 LENGTH (L)		寬度 WIDTH (W)		最大束徑 BUNDLE DIA. (MAX.)		拉伸強度 TENSILE STRENGTH (MIN.)		包裝 PACKING pcs / Bag	
	mm	inch	mm	inch	mm	inch	kgs	lbs		
GT-18S <sup>1</sup>	80	3.2	2.4	0.09	15	0.59	8	18	100 & 1000 pcs	
GT-18S <sup>2</sup>	90	3.6			16	0.63				
GT-18S <sup>3</sup>	100	4.0			18	0.71				
GT-18S <sup>4</sup>	120	4.8			30	1.18				
GT-18M <sup>1</sup>	140	5.6	2.5	0.10	35	1.38	18	40		
GT-18M <sup>2</sup>	160	6.4			40	1.57				
GT-18L	200	8.0			50	1.97				
GT-40S	150	6.0			33	1.30				
GT-40M	200	8.0	3.6	0.14	50	1.97	22	50		
GT-40M <sup>2</sup>	250	10.0			60	2.36				
GT-40L	300	12.0			76	2.99				
GT-40L <sup>2</sup>	370	14.8			102	4.02				
GT-50ES	120	4.8	4.8	0.19	24	0.94	54	120		
GT-50S <sup>1</sup>	160	6.4			38	1.50				
GT-50S <sup>2</sup>	190	7.6			43	1.69				
GT-50S <sup>3</sup>	200	8.0			50	1.97				
GT-50S <sup>4</sup>	250	10.0			60	2.36				
GT-50M	300	12.0			76	2.99				
GT-50L <sup>1</sup>	368	14.7	4.8	0.19	102	4.02	100 pcs			
GT-50LE	390	15.6			105	4.13				
GT-50L <sup>2</sup>	432	17.3			110	4.33				
GT-50L <sup>3</sup>	530	20.8			140	5.51				
GT-50L <sup>4</sup>	630	25			180	7.1				
GT-50L <sup>5</sup>	730	28.5			210	8.3				
GT-50L <sup>6</sup>	820	32			240	9.4				
GT-50LL	920	36.2			274	10.79				
GT-120ES	150	6.0			7.6	0.30		36	1.42	120
GT-120S	200	8.0						50	1.97	
GT-120S <sup>2</sup>	250	10.0	65	2.56						
GT-120EM	300	12.0	76	2.99						
GT-120M	368	14.7	102	4.02						
GT-120M <sup>1</sup>	430	17.2	110	4.33						
GT-120ML	450	17.7	115	4.5						
GT-120M <sup>2</sup>	470	18.8	120	4.72						
GT-120M <sup>3</sup>	533	21.3	140	5.51						
GT-120M <sup>4</sup>	630	24.4	165	6.50						
GT-120L	710	28.4	190	7.48						

# Heavy Duty & Heat-Stablized Cable Tie / 寬型強力束帶&耐熱束帶

Heavy Duty Cable Tie		寬型強力束帶	
MATERIAL	UL Approved Nylon (PA) 6/6	材質	採用UL合格之Nylon 6/6製成，防火等級94-V2，耐酸鹼，不易老化，承受力強
COLOR	Natural Or Black, Other Special Color, Heat Stabilized & Weather Resistance Material is Also Available	顏色	標準色為尼龍本色(白色)或黑色；另外也接受訂製特殊顏色、抗UV及耐高溫等材質
FLAME-RETARDANT	UL 94-V2	操作溫度	最高達85 °C (標準型)
TEMPERATURE RANGE	Max. 85 °C (Standard)		

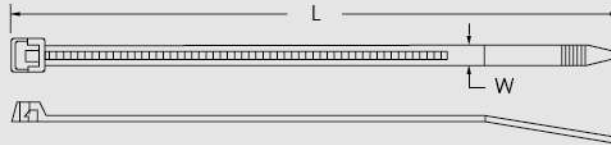

## PRODUCTS SPECIFICATION 產品規格

型號 ITEM NO.	長度 LENGTH (L)		寬度 WIDTH (W)		最大束徑 BUNDLE DIA. (MAX.)		拉伸強度 TENSILE STRENGTH (MIN.)		包裝 PACKING pcs / Bag
	mm	inch	mm	inch	mm	inch	kgs	lbs	
GT-175ES	430	17.2	9.0	0.35	110	4.33	79	175	100 pcs
GT-175S	533	21.3			140	5.51			
GT-175M	660	26.4			175	6.89			
GT-175L	710	28.4			190	7.48			
GT-175L <sup>1</sup>	780	31.2			228	8.98			
GT-175L <sup>2</sup>	812	32.5			239	9.41			
GT-175L <sup>3</sup>	920	36.8			274	10.79			
GT-175L <sup>4</sup>	1020	40.8			306	12.05			
GT-175L <sup>5</sup>	1220	48.0	367	14.5					
GT-250S	480	19.2	12.6	0.50	137	5.4	114	250	
GT-250M	580	23.2			169	6.7			
GT-250M <sup>1</sup>	730	28.7			217	8.5			
GT-250L	1030	41.2			312	12.3			

Heat-Stablized Cable Tie		耐熱束帶	
MATERIAL	UL Approved Nylon (PA66)	材質	採用UL合格之尼龍製成
COLOR	Light Green or Black	顏色	淺綠色，另也可接受訂製黑色
FLAME-RETARDANT	UL 94-V2	操作溫度	-40 °C ~130 °C
TEMPERATURE RANGE	-40 °C ~130 °C		

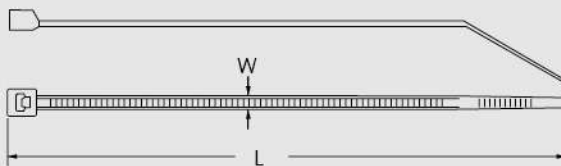

## PRODUCTS SPECIFICATION 產品規格

型號 ITEM NO.	長度 LENGTH (L)		寬度 WIDTH (W)		最大束徑 BUNDLE DIA. (MAX.)		拉伸強度 TENSILE STRENGTH	
	mm	inch	mm	inch	mm	inch	kgs	lbs
GT-18S3-HS	100	4	2.5	0.09	18	0.7	8	18
GT-40S-HS	150	5.9	3.6	0.14	33	1.38	18	40
GT-40M-HS	200	8			50	2		
GT-50M-HS	300	11.6	4.8	0.19	76	3	22	50
GT-50L1-HS	368	14.5			102	4		

# Releasable Cable Tie / 可退式束帶

PRODUCTS DESCRIPTION		產品描述	
MATERIAL	UL Approved Nylon (PA66)	材質	採用UL合格之Nylon (尼龍)6/6製成
COLOR	Natural Or Black. Other Special Color	顏色	標準色為尼龍本色及黑色，另外也接受訂製特殊顏色
FLAME-RETARDANT	UL 94-V2	防火等級	UL 94-V2
Finger catch design to release cable tie locking. Good for temporary fastening Purpose.		特點	束緊後可鬆開的設計，方便重複使用

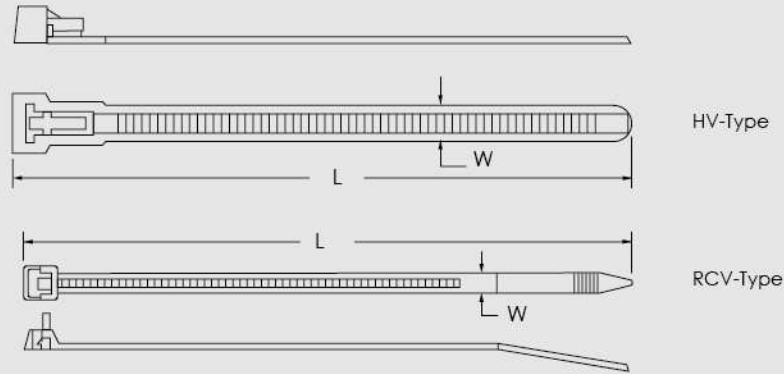
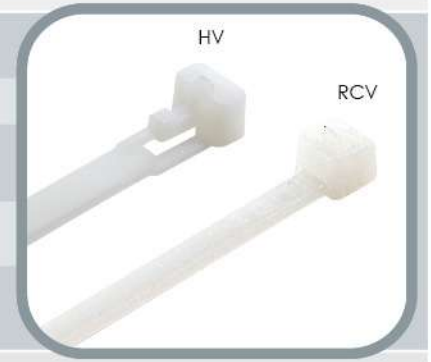

## PRODUCTS SPECIFICATION 產品規格

ITEM NO.	長度 LENGTH (L)		寬度 WIDTH (W)		最大束徑 BUNDLE DIA. (MAX.)		拉伸強度 TENSILE STRENGTH (MIN.)		包裝 PACKING
	mm	inch	mm	inch	mm	inch	kgs	lbs	
HV-125	125	5.0	7.6	0.30	30	1.18	22	50	100 pcs
HV-150	150	6.0			35	1.38			
HV-200	200	8.0			50	1.97			
HV-250	250	10.0			65	2.56			
HV-300	300	12.0			80	3.15			
HV-370	370	14.8			108	4.25			
RCV-200	200	8.0	4.8	0.19	55	2.16	22	50	
RCV-250	250	10			74	2.90			
RCV-300	300	12			80	3.14			
RCV-370	370	14.8			102	4.02			
RCV-450	450	17.7	9.0	0.35	124	4.80	79	175	

# Marker Tie / 標示牌束帶

PRODUCTS DESCRIPTION		產品描述	
MATERIAL	UL Approved Nylon (PA66)	材質	採用UL合格之Nylon (尼龍)6/6製成
COLOR	Natural Or Black. Other Special Color is Also Available	顏色	本色/黑色/特殊顏色訂製
FLAME-RETARDANT	UL 94-V2	防火等級	UL94V-2
Identify bundles of cable in one operation Flat area may be imprinted or written on it.		特點	束帶前端結合空白銘牌設計，可用油性筆在上面書寫及標記號

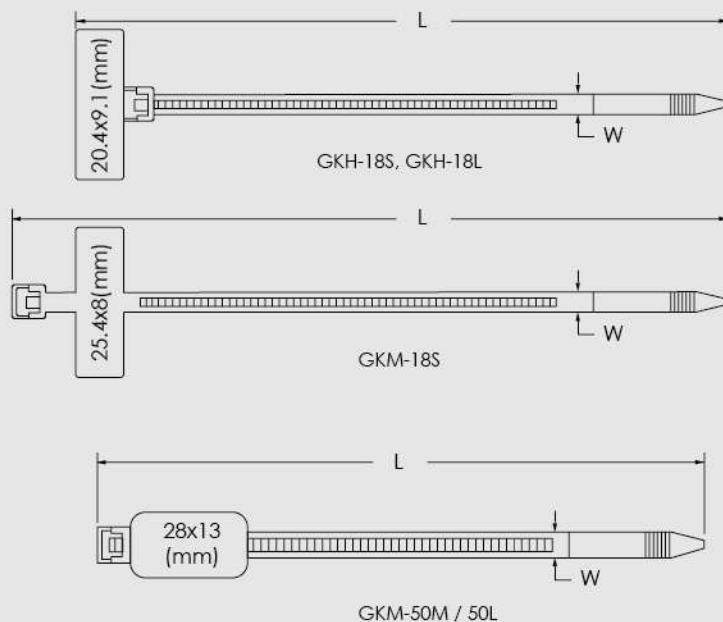
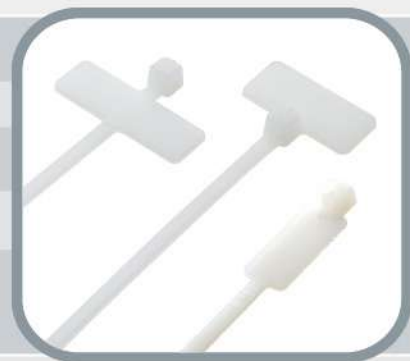

## PRODUCTS SPECIFICATION 產品規格

型號 ITEM NO.	長度 LENGTH (L)		寬度 WIDTH (W)		最大束徑 BUNDLE DIA.(MAX.)		拉伸強度 TENSILE STRENGTH		包裝 PACKING
	mm	inch	mm	inch	mm	inch	kgs	lbs	pcs/Bag
GKH-18S	112	4.4	2.5	0.1	18	0.72	8	18	100 pcs
GKH-18L	210	8.3			50	2.00			
GKM-18S	100	4.0			18	0.72			
GKM-50M	200	8.0	4.8	0.19	50	2.00	22	50	
GKM-50L	300	11.8			76	2.99			
GKM-50L <sup>1</sup>	385	15.1			105	4.13			

# Velcro Cable Tie (Releasable) / 粘扣式束帶 / 粘扣帶

PRODUCTS DESCRIPTION		產品描述	
MATERIAL	Polyamide (PA)	材質	尼龍
COLOR	Black / Blue / Green / Red White / Yellow	顏色	黑色/藍色/綠色/紅色/白色/黃色
It is reusable, adjustable, releasable and easy to install in cable fastening.		特點	產品本身具重複貼合分開的特性，材質柔軟可隨意彎曲，適用於各種網綁工作，寬度及長度皆可訂製



## PRODUCTS SPECIFICATION 產品規格

型號 ITEM NO.	寬度 WIDTH (W)	長度 LENGTH (L)	顏色 Color					
	mm	mm	Black	Blue	Green	Red	White	Yellow
VCT-150	14	150						
VCT-200	14	200						
VCT-250	14	250						

PRODUCTS DESCRIPTION		產品描述	
MATERIAL	Polyamide (PA)	材質	尼龍
COLOR	Black / Blue / Green / Red White / Yellow	顏色	黑色/藍色/綠色/紅色/白色/黃色
It is reusable, adjustable, releasable and easy to install in cable fastening.		特點	產品本身具重複貼合分開的特性，材質柔軟可隨意彎曲，適用於各種網綁工作，寬度及長度皆可訂製



## PRODUCTS SPECIFICATION 產品規格

型號 ITEM NO.	寬度 WIDTH (W)	長度 LENGTH (L)	顏色 Color					
	mm	M(米) / R(捲)	Black	Blue	Green	Red	White	Yellow
VCT-R10	10	20						
VCT-R12	12	20						
VCT-R16	16	20						
VCT-R19	19	20						
VCT-R20	20	20						



# Locking / Mounting Cable Tie / 鎖孔式束帶

PRODUCTS DESCRIPTION		產品描述	
MATERIAL	UL Approved Nylon 6/6	材質	採用UL合格之Nylon 6/6製成，防火等級94-V2，耐酸鹼，不易老化，承受力強，帶頭附加螺絲固定座，兼具電線結束整理及固定等功用
COLOR	Natural Or Black, Other Special & Weather Resistance Material Is Also Available		
FLAME-RETARDANT	UL 94-V2	顏色	標準色為尼龍本色(白色)或黑色；另外也接受訂製特殊顏色、抗UV及耐高溫等材質
TEMPERATURE RANGE	Max. 85 °C (Standard)	操作溫度	最高達85 °C (標準型)

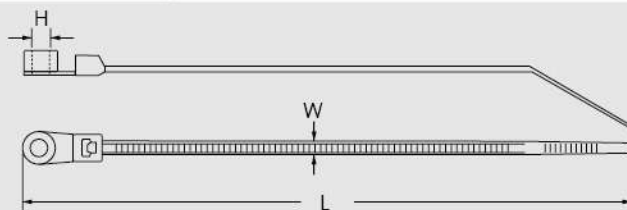

## PRODUCTS SPECIFICATION 產品規格

型號 ITEM NO.	長度 LENGTH (L)		寬度 WIDTH (W)		螺絲孔 SCREW HOLE (H)	最大束徑 BUNDLE DIA.(MAX.)		拉伸強度 TENSILE STRENGTH (MIN.)		包裝 PACKING
	mm	inch	mm	inch	mm	mm	inch	kgs	lbs	pcs / Bag
GS-40	160	6.4	3.6	0.14	4.5	40	1.57	18	40	100 & 1000 pcs
GS-50S	205	8.0	4.8	0.19	5.5	50	1.97	22	50	
GS-50M	300	12.0		0.19		76	2.99			
GS-50L	370	14.8	0.19	102		4.02				
GS-120ES	150	6.0	7.6	0.30	6.5	36	1.38	54	120	
GS-120S	200	8.0		0.30		50	1.97			
GS-120S <sup>1</sup>	250	10.0		0.30		60	2.36			
GS-120S <sup>2</sup>	300	12.0		0.30		76	2.90			
GS-120	370	14.8		0.30		102	4.02			

## TEFZEL Cable Tie / 鐵氟龍束帶

PRODUCTS DESCRIPTION		產品描述	
MATERIAL	TEFZEL ® ETFE	材質	採用 TEFZEL ® ETFE 製成，防火等級 94-V0，耐強酸鹼，耐輻射，耐高溫承受力強，適用於核能設施及化學處理工廠等特殊用途。
COLOR	Aqua Blue		
FLAME-RETARDANT	UL 94-V0	顏色	標準色為水藍色
TEMPERATURE RANGE	-60 °C ~170 °C	操作溫度	-60 °C ~170 °C

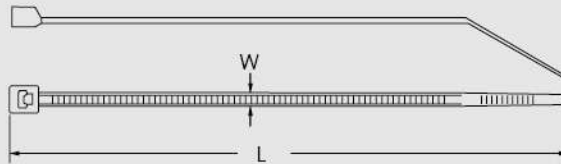

### PRODUCTS SPECIFICATION 產品規格

型號 ITEM NO.	長度 LENGTH (L)		寬度 WIDTH (W)		最大束徑 BUNDLE DIA. (MAX.)		拉伸強度 TENSILE STRENGTH	
	mm	inch	mm	inch	mm	inch	kgs	lbs
GT-18S-TEF	102	4	2.5	0.10	22	0.87	8	18
GT-40M-TEF	203	8	3.4	0.14	51	2	11	25
GT-50M-TEF	295	11.6	4.8	0.19	76	3	22	50
GT-50L-TEF	371	14.6	4.8	0.19	102	4	22	50
GT-120M-TEF	371	14.6	7.6	0.75	102	4	54	120

## Acid & Alkali Cable Tie / 耐酸鹼束帶

PRODUCTS DESCRIPTION		產品描述	
MATERIAL	Polypropylene	材質	PP材質
Ideal for applications that demand a cable tie material that provides superior chemical resistance to salts, bases and acids in various solutions and concentrations.		提供卓越的耐化學性，適用於高鹽分，酸和鹼如：電鍍槽等嚴苛的化學工作環境。	

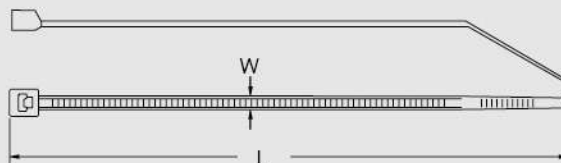

### PRODUCTS SPECIFICATION 產品規格

型號 ITEM NO.	長度 LENGTH (L)		寬度 WIDTH (W)		最大束徑 BUNDLE DIA. (MAX.)		拉伸強度 TENSILE STRENGTH	
	mm	inch	mm	inch	mm	inch	kgs	lbs
GT-40S-AA	142	5.6	3.6	0.14	35	1.38	8	18
GT-50S2-AA	188	7.4	4.8	0.19	42	1.68	14	30
GT-50M-AA	292	11.5			76	3		

## Security Tie / 保密束帶

PRODUCTS DESCRIPTION		產品描述
MATERIAL	UL Approved Nylon (PA)66	材質 採用UL合格之尼龍66製成
COLOR	Red / Yellow / Blue / Green	顏色 紅/黃/藍/綠
<p>The cable tie for the purpose of identification for security service logistics, transportation and courier. The marker plate could be carved Serial Number / LOGO upon customer's request.</p>		<p>此款產品主要適用於保全、物流、運輸、快遞業之鉛封識別用，其標示牌內容可隨客戶需求而刻印流水編號或公司識別LOGO。</p>



### PRODUCTS SPECIFICATION 產品規格

型號 ITEM NO.	長度 LENGTH (L)	寬度 WIDTH (W)	最大束徑 BUNDLE DIA. (MAX.)	標示牌尺寸 MARKING PAD
	mm	mm	mm	mm
STP-160	160	4.8	20	20x39
STP-255	255		50	
STP-300	300		65	
STP-355	355		82	
STP-405	405		98	

## Printed Cable Ties / 印刷束帶

PRODUCTS DESCRIPTION		產品描述
MATERIAL	UL Approved Nylon (PA)66	材質 採用UL合格之尼龍66製成
COLOR	Natural Color or Black, other special color is available	顏色 標準色為本色或黑色；另外也接受訂製特殊顏色。
<p>The cable tie also be custom printed to include a company name, logo, serial number...etc. Printable cable tie width of 4.8mm or wider</p>		<p>依照客製化的需要，將需要印製內容：如流水號/公司名稱/LOGO...等，印製在帶身 可印製的最小束帶寬為4.8mm 以上規格</p>



# Stainless Steel Cable Tie (With Ball Lock) / 珠式不銹鋼束帶

PRODUCTS DESCRIPTION		產品描述	
MATERIAL	AISI 316 / 304 Stainless Steel	材質	耐腐蝕不銹鋼316 S.S / 304 S.S
TEMPERATURE RANGE	-60 °C ~ 300 °C	操作溫度	-60 °C ~ 300 °C
Quickly & Easily installation than traditional metal strapping systems, the strong feature suit for indoor, outdoor and underground, especially focus on tough environment which like Telecommunication, Marine Vessels, Aircraft & Engineering Mechanism.		特點	採用特殊鋼珠自鎖設計，在使用上比傳統的金屬打包帶更為快速且較容易上手，強勁且耐腐蝕特性，可適用在室內外及地下..等特殊工作環境，尤其是針對通訊、輸油管、海運、航空器及工程機械..等用途

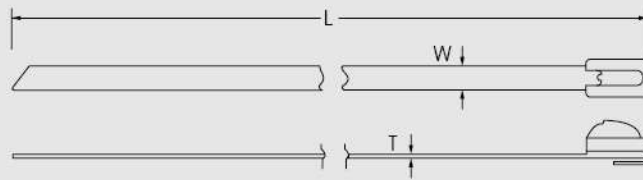

BCT: Without coating (304 S.S / 316 S.S)  
 CBCT: Epoxy coating on stripping (316 S.S)

SUS 316/304 T=0.010" (0.25mm)

## PRODUCTS SPECIFICATION 產品規格

型號 ITEM NO.	長度 LENGTH (L)		寬度 WIDTH (W)		最大束徑 BUNDLE DIA. (MAX.)		拉伸強度 LOOP TENSILE (MIN.)		包裝 PACKING
	mm	inch	mm	inch	mm	inch	kgs	lbs	pcs / Bag
BCT-450127	127	5	4.6	.18	20	0.8	45.3	100	100
BCT-450152	152	6			25	1.0			
BCT-450201	201	8			50	2.0			
BCT-450266	266	11			72	2.9			
BCT-450300	300	12			82	3.3			
BCT-450362	362	14			102	4.0			
BCT-450521	521	20			152	6.0			
BCT-450679	679	27			203	8.0			
BCT-450838	838	33			254	10.0			
BCT-450998	998	40			305	12.2			
BCT-451250	1250	50			385	15.4			
BCT-800152	152	6	7.9	.32	25	1.0	113.3	250	100
BCT-800201	201	8			50	2.0			
BCT-800266	266	11			72	2.9			
BCT-800300	300	12			82	3.3			
BCT-800362	362	14			102	4.0			
BCT-800521	521	20			152	6.0			
BCT-800679	679	27			203	8.0			
BCT-800838	838	33			254	10.0			
BCT-800998	998	41			305	12.2			
BCT-801250	1250	50			385	15.4			
BCT-120300	300	12.0			12.7	.51			
BCT-120434	434	17.4	116	4.6					
BCT-120594	594	23.8	165	6.5					
BCT-120754	754	30.2	220	8.7					
BCT-120912	912	36.5	270	10.6					
BCT-121072	1072	42.9	321	12.6					

# Stainless Steel Cable Tie (Ladder Type) / 梯型不銹鋼束帶

PRODUCTS DESCRIPTION		產品描述	
MATERIAL	AISI 316 Stainless Steel	材質	耐腐蝕不鏽鋼316 S.S.
TEMPERATURE RANGE	-60 °C ~ 300 °C	操作溫度	-60 °C ~ 300 °C
<p>The unique multi-locking design could make installation more quickly &amp; easily. Besides using corrosion resistant S.S. 316, the coated with Nylon 11 for excellent chemical &amp; weathering resistance. The feature suit for indoor, outdoor and underground, especially focus on tough environment which like Telecommunication, Marine Vessels, Aircraft &amp; Engineering Mechanism.</p>		特點	<p>採用獨特地多重扣鎖設計，在使用簡單且快速，除了本身材質具耐腐蝕性，更可在表層加上無毒尼龍披附，增強其抗酸鹼及耐候性，可適用在室內外及地下..等特殊工作環境，尤其是針對通訊、輸油管、海運、航空器及工程機械..等用途。</p>

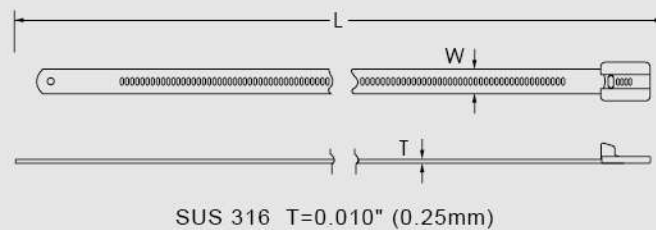

- LCT1: Without Coating
- LCT2: Polyester Coating
- LCT3: Nylon 11 Coating

SUS 316 T=0.010" (0.25mm)

## PRODUCTS SPECIFICATION 產品規格

型號 ITEM NO.	長度 LENGTH (L)		寬度 WIDTH (W)		最大束徑 BUNDLE DIA.(MAX.)		環形拉伸 LOOP TENSILE (MIN.)		包裝 PACKING
	mm	inch	mm	inch	mm	inch	kgs	lbs	pcs / Bag
LCT1-07150	150	5.9	7	.28	22	0.9	113.4	250	100
LCT1-07195	195	7.7			45	1.8			
LCT1-07225	225	8.9			54	2.2			
LCT1-07255	255	10.0			64	2.6			
LCT1-07300	300	11.8			78	3.1			
LCT1-07335	335	13.2			89	3.6			
LCT1-07375	375	14.8			102	4.1			
LCT1-07450	450	17.7			126	5.0			
LCT1-07610	610	24.0			177	7.1			
LCT1-12195	195	7.7	12	.47	45	1.8	113.4	250	50
LCT1-12225	225	8.9			54	2.2			
LCT1-12255	255	10.0			64	2.6			
LCT1-12300	300	11.8			78	3.1			
LCT1-12335	335	13.2			89	3.6			
LCT1-12375	375	14.8			102	4.1			
LCT1-12450	450	17.7			126	5.0			
LCT1-12610	610	24.0			177	7.1			

# Stainless Steel Cable Tie (Releasable Type) / 可退式不銹鋼束帶

PRODUCTS DESCRIPTION		產品描述	
MATERIAL	AISI 316 Stainless Steel	材質	耐腐蝕不銹鋼316 S.S.
TEMPERATURE RANGE	-60 °C ~ 300 °C	操作溫度	-60 °C ~ 300 °C
<p>The design provides quick and easy application and can just easily be released for reuse. Halogen-Free Nylon coating has excellent chemical &amp; weathering resistance, long life expectancy and UV-resistant.</p>		特點	<p>可退式設計增加產品重覆使用性，除了本身材質具耐腐蝕性，表層無毒材質尼龍披附，可增強抗酸鹼性、抗紫外線及耐候性，使產品延長使用壽命到最佳化。</p>

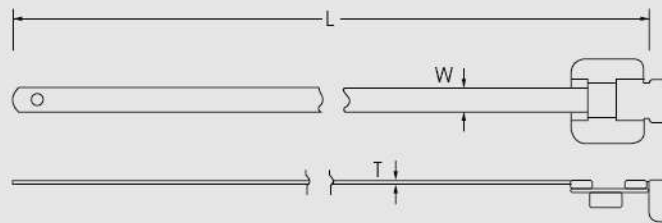

SUS 316 T=0.015" (0.4mm)

SCT2: Polyester Coating  
SCT3: Nylon 11 coating

## PRODUCTS SPECIFICATION 產品規格

型號 ITEM NO.	長度 LENGTH (L)		寬度 WIDTH (W)		最大束徑 BUNDLE DIA.(MAX.)		環形拉伸 LOOP TENSILE (MIN.)		包裝 PACKING
	mm	inch	mm	inch	mm	inch	kgs	lbs	pcs / Bag
SCT-152S	152	6	6.3	.248	38	1.5	136	300	100
SCT-229S	229	9			63	2.5			
SCT-305S	305	12			86	3.5			
SCT-457S	457	18			137	5.4			
SCT-610S	610	24			185	7.3			

# Wire Tie Mount & Cable Clamp / 電線固定座 & 固定鈕(夾)

<b>CABLE CLAMP / HOSE CLAMP</b>		<b>固定鈕/管夾</b>	
MATERIAL	UL Approved Nylon 6/6	材質	採用UL合格之Nylon 6/6製成，防火等級94-V2，耐酸鹼，不易老化，承受力強
FLAME-RETARDANT	UL 94-V2	顏色	標準色為尼龍本色(白色)或黑色
USED METHOD	To clamp on loosen cables and screw it to chassis.	操作溫度	-40 °C ~ 85 °C
		特點	可將電線或電纜固定於扣內，再以螺絲上緊即可固定於機板上

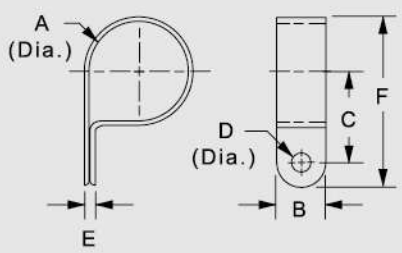

DIMENSIONS mm (inch)						
型號 ITEM NO.	A	B	C	D	E	F
1/8(S)	3.2(0.13)	9.5(0.37)	8.3(0.33)	5.2(0.21)	2.6(0.10)	18.2(0.72)
1/8	3.2(0.13)	13.2(0.54)	8.3(0.33)	5.2(0.21)	2.6(0.10)	18.2(0.72)
3/16	4.5(0.18)	9.7(0.39)	12.5(0.41)	5.2(0.21)	2.6(0.10)	19.0(0.76)
1/4	6.3(0.25)	9.7(0.39)	10.5(0.41)	5.2(0.21)	2.6(0.10)	21.0(0.84)
5/16	7.6(0.30)	9.7(0.39)	12.0(0.47)	4.8(0.19)	2.6(0.10)	22.8(0.91)
3/8	9.3(0.37)	9.7(0.39)	12.5(0.49)	4.8(0.19)	2.6(0.10)	22.8(0.91)
3/8(W)	9.5(0.37)	12.7(0.50)	13.4(0.52)	5.3(0.20)	2.6(0.10)	26.3(1.04)
1/2	12.6(0.50)	12.8(0.50)	15.0(0.59)	5.2(0.21)	2.6(0.10)	29.0(1.16)
5/8	15.8(0.62)	12(0.47)	18.2(0.72)	4.6(0.18)	2.6(0.10)	34.4(1.35)
3/4	19.4(0.76)	12(0.47)	18.2(0.72)	5.3(0.20)	2.6(0.10)	35.0(1.38)
1	25.4(1.00)	12(0.47)	22.0(0.87)	4.6(0.18)	2.6(0.10)	43.0(1.69)
1-1/8	28.6(1.13)	12.7(0.50)	21.4(0.84)	4.6(0.18)	2.6(0.10)	42.3(1.67)
1-1/4	31.8(1.25)	12(0.50)	26.2(1.03)	4.6(0.18)	2.6(0.10)	46.2(1.82)
1-1/2	36.7(1.44)	12(0.50)	30.0(1.18)	5.1(0.20)	2.6(0.10)	50.0(1.97)

<b>SELF-ADHESIVE TIE MOUNT</b>		<b>粘式固定座</b>	
MATERIAL	UL Approved Nylon 6/6	材質	採用UL合格之Nylon 6/6製成，防火等級94-V2，背附雙面膠、絕緣性良好、耐久不易老化
FLAME-RETARDANT	UL 94-V2	顏色	標準色為尼龍本色(白色)或黑色
USED METHOD	To apply, simply peel off backing paper and apply mount to surface. After that, cable tie can be inserted to secure wire bundles.	特點	使用時將背膠撕去封紙，再將固定座貼於固定處表面，後再配合紮線帶穿於帶孔使用，可省去鑽孔之麻煩

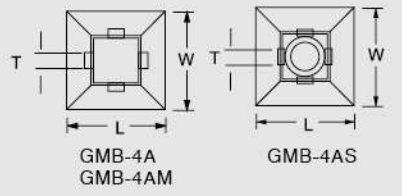

DIMENSIONS					
型號 ITEM NO.	長度 Length (L) mm (inch)	寬度 Width (W) mm (inch)	高度 Height (H) mm (inch)	孔 Hole mm (inch)	束帶寬度 Tie Width (T) mm (inch)
GMB-4A	19(0.75)	19(0.75)	5.0(0.2)	none	4.0(0.16)
GMB-4AM	21.8(0.85)	21.8(0.85)	5.0(0.2)	none	4.8(0.19)
GMB-4AS	28(1.1)	28(1.1)	5.7(0.22)	5.0(0.20)	5.0(0.20)

<b>SADDLE TYPE TIE MOUNT</b>		<b>馬鞍型鎖式固定座</b>	
MATERIAL	UL Approved Nylon 6/6	材質	採用UL合格之Nylon 6/6製成，防火等級94-V2，耐酸鹼，不易老化，承受力強
FLAME-RETARDANT	UL 94-V2	操作溫度	-40 °C ~ 85 °C
USED METHOD	Simply fix mount with a screw and secure wire bundles with nylon cable tie.	顏色	標準色為尼龍本色(白色)或黑色
		特點	先用螺絲固定後再配合紮線帶穿於帶孔使用

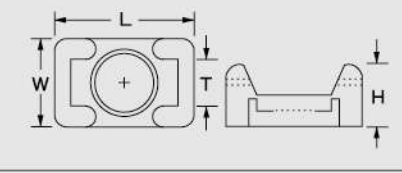

DIMENSIONS					
型號 ITEM NO.	長度 Length (L) mm (inch)	寬度 Width (W) mm (inch)	高度 Height (H) mm (inch)	束帶寬度 Tie Width (T) mm (inch)	螺絲孔 Screw Hole mm
GCM-S	15(0.59)	10(0.39)	7(0.28)	5.0 (0.20)	3.5
GCM-L	23(0.91)	16(0.63)	9(0.35)	9.0 (0.35)	5.5

# Metal Cable Clamp / 金屬固定鈕

## PVC Coating

MATERIAL	Stainless Steel
INSULATION	PVC
USED METHOD	To clamp on loosen cables and screw it to chassis.

材質	不銹鋼
被覆	PVC
特點	可將電線或管材固定於扣內，再以螺絲上緊即可固定於機板上



### DIMENSIONS mm (inch)

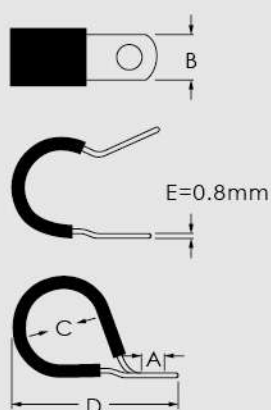

型號 ITEM NO.	A	B	C	D
1/4	7.0	12.7	6.4	34.0
5/16	7.0	12.7	7.9	34.7
7/16	7.0	12.7	11.1	38.4
9/16	7.0	12.7	14.3	43.5
3/4	7.0	12.7	19.1	48.6
7/8	7.0	12.7	22.2	54.0
1	7.0	12.7	25.4	59.0
3/16	7.0	12.7	4.8	30.0
3/8	7.0	12.7	9.5	38.1
1/2	7.0	12.7	12.7	43.1
5/8	7.0	12.7	15.9	48.8
1-1/4	7.0	12.7	31.8	72.0
1-1/2	7.0	12.7	36.7	79.0
1-3/4	7.0	12.7	44.4	86.0
2	7.0	12.7	50.8	93.0
2-1/2	7.0	12.7	63.5	114.0
3	7.0	12.7	76.2	128.0

## Rubber Insulation

MATERIAL	Steel
INSULATION	Rubber
USED METHOD	To clamp on loosen cables and screw it to chassis.

材質	鍍鋅鋼
被覆	橡膠
特點	可將電線或管材固定於扣內，再以螺絲上緊即可固定於機板上



### DIMENSIONS mm (inch)

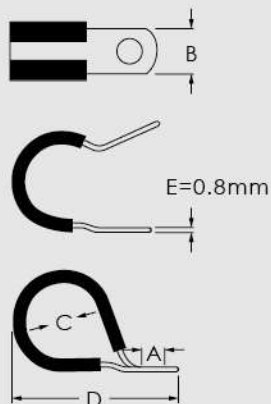

型號 ITEM NO.	A	B	C	D
3/8	6.7	12.0	9.5	38.1
1/2	6.7	12.0	12.7	43.1
5/8	6.7	12.0	15.9	48.8
3/4	6.7	12.0	19.1	48.6
7/8	6.7	12.0	22.2	54.0
1	6.7	12.0	25.4	59.0
1-1/4	6.7	12.0	31.8	72.0



# Wire Duct (Slot / Solid) / 配線槽

## PRODUCTS DESCRIPTION

**MATERIAL** Rigid, High Impact, Self-extinguishing, RoHS Compliance PVC

**COLOR** Grey, Ivory & White

Used Primarily In Control Panels, The Restricted Slot Design Allow Wires To Be Added Or Removed By Simply Deflecting The Fingers On The Side Of The Duct. All Size Can Be Slot or Solid.

## 產品描述

**材質** 採用低鹵素半硬質PVC料精製，絕緣佳、不自燃且耐高溫

**顏色** 標準色為灰色，另外也接受訂製特殊顏色

**特點** 整體構造由槽底及上蓋組成，槽底兩側設出線孔，組合容易不脫落，接合面平滑不傷手，如欲增加線路或維修時，把蓋子打開即可進行工作

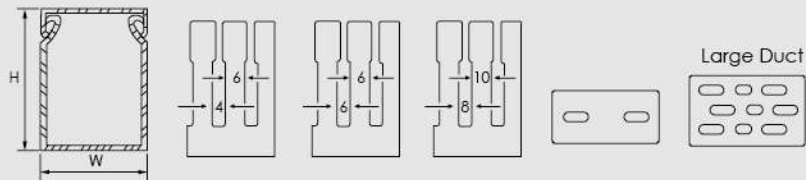
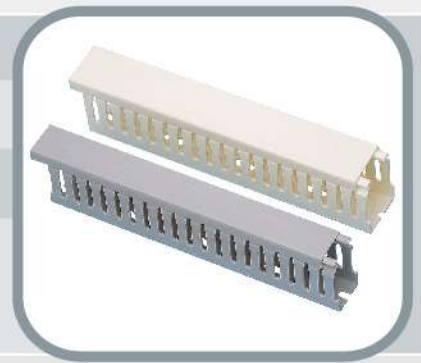

## PRODUCTS SPECIFICATION 產品規格

型號 ITEM NO.				寬 x 高 WIDTH x HEIGHT W x H (mm)	電線容量 2mm <sup>2</sup> Wire Can Be Contained (pcs)	長度 Length
密封型	出線孔型 Slot Hole Sizes					
Solid	4mm	6mm	8mm			
SD1525	WD1525-4	-----	WD1525-8	15 x 25	5~12	1. 7M or 2. 0M Per Piece
SD2525	WD2525-4	WD2525-6	WD2525-8	25 x 25	10~25	
SD2530	WD2530-4	-----	WD2530-8	25 x 30	15~25	
SD2545	WD2545-4	WD2545-6	WD2545-8	25 x 45	20~25	
SD2565	WD2565-4	WD2565-6	WD2565-8	25 x 65	40~45	
SD3333	WD3333-4	WD3333-6	WD3333-8	33 x 33	25~45	
SD3345	WD3345-4	WD3345-6	WD3345-8	33 x 45	40~55	
SD3365	WD3365-4	WD3365-6	WD3365-8	33 x 65	60~75	
SD33100	-----	-----	WD33100-8	33 x 100	180~200	
SD4040	WD4040-4	WD4040-6	WD4040-8	40 x 40	40~50	
SD4060	WD4060-4	-----	WD4060-8	40 x 60	100~115	
SD4080	WD4080-4	-----	WD4080-8	40 x 80	120~135	
SD4545	WD4545-4	WD4545-6	WD4545-8	45 x 45	60~70	
SD4565	WD4565-4	WD4565-6	WD4565-8	45 x 65	110~120	
SD5025	-----	WD5025-6	-----	50 x 25	25~45	
SD5050	WD5050-4	WD5050-6	WD5050-8	50 x 50	80~90	
SD50100	WD50100-4	-----	WD50100-8	50 x 100	200~250	
SD6060	WD6060-4	WD6060-6	WD6060-8	60 x 60	120~135	
SD6080	WD6080-4	WD6080-6	WD6080-8	60 x 80	180~210	
SD6545	WD6545-4	WD6545-6	WD6545-8	65 x 45	110~120	
SD6565	WD6565-4	WD6565-6	WD6565-8	65 x 65	180~200	
SD70100	-----	-----	WD70100-8	70 x 100	250~300	
SD7264	-----	-----	WD7264-8	72 x 64	200~220	
SD7575	-----	-----	WD7575-8	75 x 75	200~250	
SD8060	WD8060-4	-----	WD8060-8	80 x 60	180~210	
SD8080	WD8080-4	-----	WD8080-8	80 x 80	240~290	
SD10050	-----	-----	WD10050-8	100 x 50	200~250	
SD10060	WD10060-4	-----	WD10060-8	100 x 60	240~290	
SD100100	-----	-----	WD100100-8	100 x 100	300~400	
SD15060	-----	-----	-----	150 x 60	260~400	
SD15075	-----	-----	WD15075-8	150 x 75	335~500	
SD150100	-----	-----	WD150100-8	150 x 100	450~600	
SD200100	-----	-----	WD200100-8	200 x 100	600~800	
SD300100	-----	-----	-----	300 x 100	1040~1200	

## Wire Duct (Close / Solid) / 配線槽(封軌型)

### PRODUCTS DESCRIPTION

**MATERIAL** Rigid, High Impact, Self-extinguishing RoHS Compliance PVC

**COLOR** Grey, Ivory & White

Used Primarily In Control Panels, The Restricted Slot Design Allow Wires To Be Added Or Removed By Simply Deflecting The Fingers On The Side Of The Duct. All Size Can Be Slot or Solid.

### 產品描述

**材質** 採用低鹵素半硬質PVC料精製，絕緣佳、不自燃且耐高溫

**顏色** 標準色為灰色，另外也接受訂製特殊顏色

**特點** 整體構造由槽底及上蓋組成，槽底兩側設出線孔，組合容易不脫落，接合面平滑不傷手，如欲增加線路或維修時，把蓋子打開即可進行工作

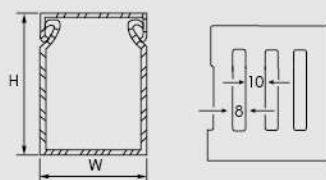
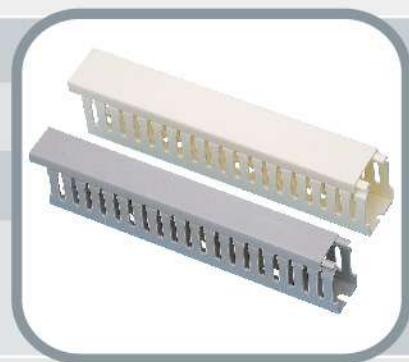

### PRODUCTS SPECIFICATION 產品規格

型號 ITEM NO.	寬 x 高 WIDTH x HEIGHT W x H (mm)	電線容量 2mm <sup>2</sup> Wire Can Be Contained (pcs)	長度 Length
出線孔 Slot 8mm			
VDC2530	25 x 30	15~25	1.7M or 2.0M Per Piece
VDC4040	40 x 40	40~50	
VDC4060	40 x 60	100~115	
VDC4080	40 x 80	120~135	
VDC5050	50 x 50	80~90	
VDC6060	60 x 60	120~135	
VDC6080	60 x 80	180~210	
VDC8080	80 x 80	240~290	
VDC100100	100 x 100	300~400	

## Round Type Wire Duct / 半圓形地板配線槽

PRODUCTS DESCRIPTION		產品描述	
MATERIAL	Rigid, High Impact, Self-extinguishing RoHS Compliance PVC	材質	採用半硬質PVC料精製，絕緣佳、不自燃且耐高溫
COLOR	Grey, Ivory & White	顏色	標準色為灰色、乳白色，另外也接受訂製特殊顏色
Designed To Protect Wires On Floor, won't trip up persons & trolley's movement.		特點	槽蓋採半圓弧設計，不易因使用於地板時絆倒人，更易於搬運用台車通過

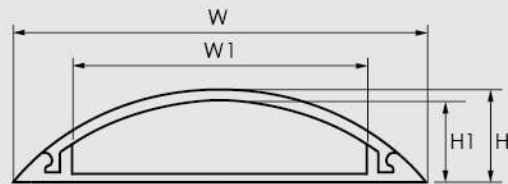
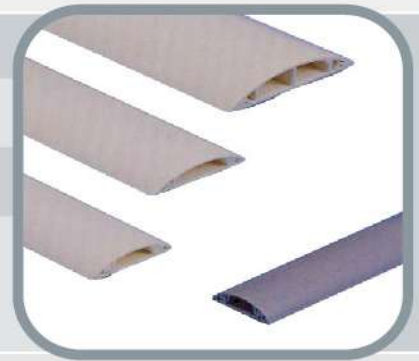

### PRODUCTS SPECIFICATION 產品規格

型號 ITEM NO.	尺寸 DIMENSIONS inch (mm)				長度 Length
	W	W1	H	H1	
RD-20	20	10	7.0	5.0	1M Per PC
RD-30	30	17	9.5	7.5	
RD-40	40	24	10.0	8.0	
RD-50	50	31	11.5	9.0	
RD-60	60	38	14.5	11.0	
RD-70	70	45	16.5	13.0	

# Telephone & Decoration Wire Duct / 電話&防盜壓條

PRODUCTS DESCRIPTION		產品描述	
MATERIAL	Rigid, High Impact, Self-extinguishing RoHS Compliance PVC	材質	採用半硬質PVC料精製，絕緣佳、不自燃且耐高溫
COLOR	Grey, Ivory & White	顏色	標準色為灰色、乳白色及咖啡色，另外也接受訂製特殊顏色
Designed To Protect Wires On Floor and could match the color of decoration		特點	保護電線增加美觀性，可與裝潢色調配合

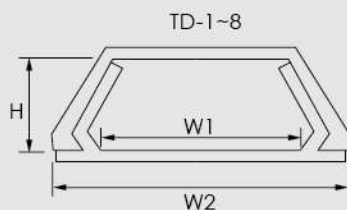

## PRODUCTS SPECIFICATION 產品規格

型號 ITEM NO.	尺寸 DIMENSION (mm)			包含電線 Wire Contained (PCS) (Based on 0.8mm)	長度 Length
	W1	W2	H		
TD-1	9.0	14.5	4.0	1	1M Per Piece
TD-2	11.0	18.0	7.0	2~3	
TD-3	12.5	19.5	8.0	3~4	
TD-4	14.5	23.5	12.0	4~7	
TD-5	16.0	26.0	15.5	7~9	
TD-6	19.0	30.0	17.0	10~15	
TD-8	37.5	49.0	18.0	30~40	



## PRODUCTS SPECIFICATION 產品規格

型號 ITEM NO.	尺寸 DIMENSION (mm)			包含電線 Wire Contained (PCS) (Based on 0.8mm)	長度 Length
	W1	W2	H		
DF-1	12	13.5	9	1~4	1M Per Piece
DF-2	17.5	19	9	2~6	
DF-3	23	25	9	5~9	
DF-4	29.5	32	9	6~12	

## Spiral Wrapping Band / 捲式結束帶

### PRODUCTS DESCRIPTION

MATERIAL PE

COLOR White Or Black

An economical way of cable binding and protection. Easily applied to electric harness, cables and wire bundles. Cut-to-fit versatility in convenient roll-form.

### 產品描述

材質 使用PE料製成

顏色 白色或黑色

特點 作為保護電線不受磨損及絕緣用，並可增進電線彎曲的美觀

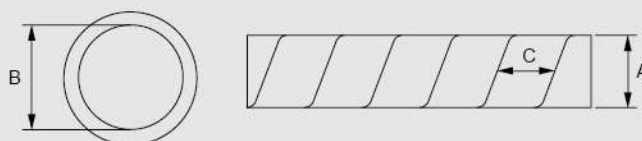

### PRODUCTS SPECIFICATION 產品規格

型號 ITEM NO.	I.D. (內徑) B	O.D. (外徑) A	螺距 C	Wrapping Range Ø(mm)	包裝 Packing
CS-3	1.5	3	4.0	1.5~18	10M Per Bag
CS-6	4	6	7.0	4~50	
CS-8	6	8	10.8	6~60	
CS-10	7.5	10	11.4	7.5~60	
CS-12	9	12	13.9	9~65	
CS-15	12	15	15.0	12~70	
CS-19	15	18	18.2	15~100	
CS-24	20	24	19.6	20~130	
CS-30	26	30	43.0	26~160	

### PRODUCTS DESCRIPTION

MATERIAL PE

COLOR White Or Black

Easily applied to electric harness, cables and wire bundles. Cut-to-fit versatility in convenient roll-form.

### 產品描述

材質 使用PE料製成

顏色 白色或黑色

特點 採半剖式的管狀包覆，配合集線夾的使用，快速的讓家裡原本雜亂無章的電線變得井然有序

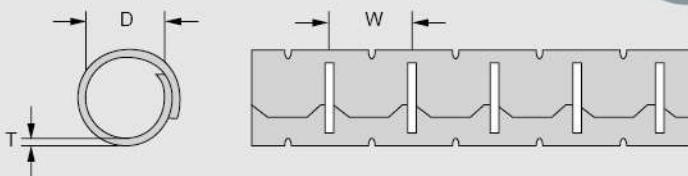

### PRODUCTS SPECIFICATION 產品規格

型號 ITEM NO.	I.D. (內徑) D	Wrapping Range Ø(mm)	Pitch (節距) W (mm)	Thickness (肉厚) T (mm)	包裝 Packing
KL-8E	8	8~10	10	0.8	5M Per Bag
KL-15E	15	15~16	14	0.8	
KL-20E	20	20~23	17	0.9	
KL-25E	25	25~29	20	1.0	
KL-32E	32	32~35	24	1.4	

# General Purpose, Heat Shrinkable Tubing / 環保熱縮套管

PRODUCTS DESCRIPTION		產品描述	
MATERIAL	Polyolefin (PE)	材 質	環保PE製成
COLOR	Black, Red, Blue, Yellow, White, Green	顏 色	黑色、紅色、藍色、黃色、白色、綠色
TEMPERATURE RANGE	Operating temperature : -55°C ~ 125°C Minimum shrink temperature : 70°C Minimum fully recovery temperature : 110°C	操作溫度	操作溫度 : -55°C ~ 125°C 最低收縮溫度 : 70°C 最低完全收縮溫度 : 110°C
VOLTAGE RANGE	600V	耐電壓值	600V
FLAME-ABILITY	VW-1	耐燃等級	VW-1
General purpose tubing for military and commercial applications such as electrical insulation and protecting in-line components, disconnect terminals, and splices. Used for jacketing wire bundles and light-duty harness and identifying or color-codes wires, cables, terminals, and components.		特 點	本產品具有環保、柔軟、阻燃..等特性,可廣泛的應用於電線連接、焊點保護、電線端部以及線束即電子元件的防護和絕緣處理,另外還常被用於顏色標識



## PRODUCTS SPECIFICATION 產品規格

型號 ITEM NO.	尺寸 Size (mm)	AS SUPPLIED 收縮前 (MM)		AFTER RECOVERY 收縮後 (MM)		PACKAGE M (米)/SPOOL (捲)
		I.D. (內徑)	W.T. (壁厚)	I.D. (內徑)	W.T. (壁厚)	
G5-0.8	∅0.8	1.0 ± 0.2	0.15 ± 0.05	0.4	0.25 ± 0.05	200
G5-1	∅1.0	1.5 ± 0.3	0.20 ± 0.05	0.6	0.33 ± 0.05	200
G5-1.5	∅1.5	2.0 ± 0.3	0.20 ± 0.05	0.75	0.36 ± 0.05	200
G5-2	∅2.0	2.5 ± 0.3	0.20 ± 0.05	1.0	0.44 ± 0.05	200
G5-2.5	∅2.5	3.0 ± 0.3	0.25 ± 0.05	1.25	0.44 ± 0.05	200
G5-3	∅3.0	3.5 ± 0.3	0.25 ± 0.05	1.5	0.44 ± 0.05	200
G5-3.5	∅3.5	4.0 ± 0.3	0.25 ± 0.05	1.75	0.44 ± 0.05	200
G5-4	∅4.0	4.5 ± 0.3	0.25 ± 0.05	2.0	0.44 ± 0.05	200
G5-4.5	∅4.5	5.0 ± 0.3	0.25 ± 0.05	2.25	0.44 ± 0.08	100
G5-5	∅5.0	5.5 ± 0.3	0.25 ± 0.05	2.5	0.56 ± 0.08	100
G5-6	∅6.0	6.5 ± 0.3	0.28 ± 0.05	3.0	0.56 ± 0.08	100
G5-7	∅7.0	7.6 ± 0.3	0.30 ± 0.06	3.5	0.56 ± 0.08	100
G5-8	∅8.0	8.6 ± 0.3	0.30 ± 0.06	4.0	0.56 ± 0.08	100
G5-9	∅9.0	9.6 ± 0.3	0.30 ± 0.06	4.5	0.56 ± 0.08	100
G5-10	∅10.0	10.7 ± 0.4	0.30 ± 0.06	5.0	0.56 ± 0.08	100
G5-11	∅11.0	11.7 ± 0.4	0.30 ± 0.06	5.5	0.56 ± 0.08	100
G5-12	∅12.0	12.7 ± 0.4	0.30 ± 0.06	6.0	0.56 ± 0.08	100
G5-13	∅13.0	13.7 ± 0.4	0.35 ± 0.07	6.5	0.69 ± 0.08	100
G5-14	∅14.0	14.7±0.4	0.35 ± 0.07	7.0	0.69 ± 0.08	100
G5-15	∅15.0	15.7±0.5	0.35 ± 0.07	7.5	0.69 ± 0.08	100
G5-16	∅16.0	16.7 ± 0.5	0.35 ± 0.07	8.0	0.69 ± 0.08	100
G5-17	∅17.0	17.5 ± 0.6	0.35 ± 0.12	8.5	0.77 ± 0.08	100
G5-18	∅18.0	19.0 ± 0.5	0.40 ± 0.10	9.0	0.77 ± 0.15	100
G5-20	∅20.0	21.0 ± 0.5	0.40 ± 0.10	10.0	0.77 ± 0.15	100
G5-22	∅22.0	23.0 ± 0.5	0.40 ± 0.10	11.0	0.77 ± 0.15	100
G5-25	∅25.0	26.0 ± 1.0	0.45 ± 0.10	12.5	0.87 ± 0.15	50
G5-28	∅28.0	29.0 ± 1.0	0.45 ± 0.10	14.0	0.87 ± 0.15	50
G5-30	∅30.0	31.5 ± 1.0	0.45 ± 0.10	15.0	0.87 ± 0.15	50
G5-35	∅35.0	37.0 ± 1.0	0.50 ± 0.10	17.5	0.97 ± 0.15	50
G5-40	∅40.0	40.5 ± 1.0	0.50 ± 0.10	20.0	0.97 ± 0.15	50
G5-45	∅45.0	46.0 ± 1.0	0.50 ± 0.10	22.5	0.97 ± 0.15	25
G5-50	∅50.0	50.5 ± 1.0	0.50 ± 0.10	25.0	0.97 ± 0.15	25
G5-60	∅60.0	60.0 ± 3.0	0.80 ± 0.20	30.0	1.30 ± 0.20	25
G5-70	∅70.0	70.0 ± 3.0	0.80 ± 0.20	35.0	1.50 ± 0.20	25
G5-80	∅80.0	80.0 ± 3.0	0.80 ± 0.30	40.0	1.50 ± 0.30	25
G5-90	∅90.0	90.0 ± 4.0	0.80 ± 0.30	45.0	1.50 ± 0.30	25
G5-100	∅100	100.0 ± 4.0	0.80 ± 0.30	50.0	1.50 ± 0.30	25
G5-120	∅120	120.0 ± 4.0	0.80 ± 0.30	60.0	1.50 ± 0.30	15
G5-150	∅150	150.0 ± 4.0	0.80 ± 0.30	75.0	1.50 ± 0.30	15
G5-180	∅180	180.0 ± 4.0	0.80 ± 0.30	90.0	1.50 ± 0.30	15

# Nylon Cable Glands / 尼龍電纜固定頭

PRODUCTS DESCRIPTION		產品描述	
MATERIAL	UL Nylon 6/6 ; 94-V2 Class, Neoprene For Seal Insert, With Nut.	材質	採用UL合格之Nylon 6/6製成，防火等級94-V2，夾緊圈為耐油橡膠材質，耐酸鹼，不易老化
COLOR	Black, Grey, Light Grey	顏色	標準色為灰色、黑色或灰白色
PROTECTION	IP68	特點	1. 夾緊圈經特殊設計，拉力強對電纜線不會造成損壞 2. 不須將固定頭解體，電纜線可直接穿入上緊，省時又方便
TEMPERATURE RANGE	-40 °C ~ 85 °C Short Time 140 °C		
The cable can be easily once inserted into through the gland without dismantling the parts. The claws and seals of excellent design can hold cable firmly and have a wider cable range.		用途	一般機械控制箱，配電盤，事務機器，電器等製品電纜線固定用



牙規:  
PG (without washer)  
METRIC  
NPT (without washer & nut)

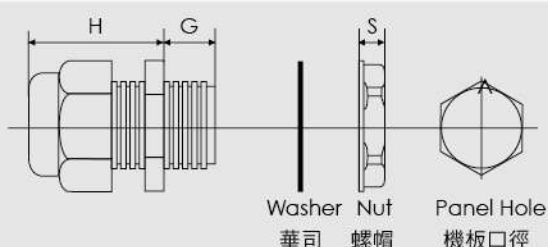

## German PG Thread, According to DIN 40430 Unit: m / m

型號 ITEM NO.	類型 Type	Panel Hole A	Cable & Body Dimension				Locking Nut Dimension	
			Cable Range		H	G	S	
5007	PG-7	12.5	3-6	15	21.7	8.1	5.3	15
5009	PG-9	15.2	4-8	19	28.2	7.5	5.6	19
5011	PG-11	18.3	5-9	22	26.2	7.9	5.4	22
5013	PG-13.5	20.3	6-12	24	31.5	8.9	6.4	24
5016	PG-16	22.4	8-14	27	31.7	9.3	6.5	29
5021	PG-21	28.3	10-18	33	38.6	11	7	33
5029	PG-29	36.9	16-25	42	41.5	11	7	42
5036	PG-36	47.4	22-32	54	51	14	9	54
5042	PG-42	54.4	28-38	59	54	14.5	9	59
5048	PG-48	59.7	36-44	64	54	15.5	9	64

## METRIC ISO Thread, According to DIN 13 Unit: m / m

型號 ITEM NO.	類型 Type	Panel Hole A	Cable & Body Dimension				Locking Nut Dimension	
			Cable Range		H	G	S	
5007M	M-12	12.3	4-7	15	23.7	11	5.3	15
5009M	M-16	16.3	5-10	22	27.2	11	5.4	22
5013M	M-20	20.3	6-13	27	33.8	12	6.5	29
5016M	M-25	25.4	10-17	33	39.6	12	7	33
5018M	M-32	32.4	14-21	42	43.1	14	7	42
5020M	M-40	40.4	19-28	54	51	14	9	54
5022M	M-50	50.4	23-35	59	54	16	9	59
5024M	M-63	63.4	32-48	68	59	17	9	68

## American NPT Thread in inches Unit: m / m

型號 ITEM NO.	類型 Type	Cable Range	Cable & Body Dimension		
				H	G
5009N	NPT-3/8	4-8	22	28	14.5
5013N	NPT-1/2	6-12	24	31.5	12.9
5021N	NPT-3/4	10-18	33	38.7	15.1

# Flexible Conduit (PP/Nylon) / 浪管

PRODUCTS DESCRIPTION		產品描述	
MATERIAL	PP / NYLON 6	材 質	PP / 尼龍 6
COLOR	Black	顏 色	黑色
For running cable protection in Electrical / Machinery / Building Harness Wiring.		特 點	可保護電線電腦不受外力磨損及絕緣，被廣泛應用在汽車、機車、機械及建築配線...等用途

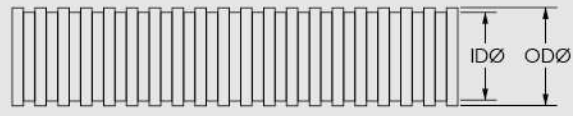

## PRODUCTS SPECIFICATION 產品規格

型號 ITEM NO.		尺寸 Size (mm)		Material (材質)	包裝 Packing
Split (半剖)	Close (密閉)	I.D. (內徑)	O.D. (外徑)		M(米) / R(捲)
CRS-05P	CR-05P	5.5	7.7	PP	300
CRS-07P	CR-07P	7.6	10.2		300
CRS-10P	CR-10P	10.7	14.0		200
CRS-13P	CR-13P	13.8	17.5		200
CRS-16P	CR-16P	15.6	20.0		200
CRS-19P	CR-19P	19.6	23.8		200
CRS-22P	CR-22P	22.5	27.0		100
CRS-24P	CR-24P	23.8	28.0		100
CRS-28P	CR-28P	28.5	34.0		100
CRS-32P	CR-32P	32.4	38.0		50

## PRODUCTS SPECIFICATION 產品規格

型號 ITEM NO.		尺寸 Size (mm)		Material (材質)	包裝 Packing
Split (半剖)	Close (密閉)	I.D. (內徑)	O.D. (外徑)		M(米) / R(捲)
CRS-05N	CR-05N	5.5	7.7	尼龍 NYLON	300
CRS-07N	CR-07N	7.6	10.2		300
CRS-10N	CR-10N	10.7	14.0		200
CRS-13N	CR-13N	13.8	17.5		200
CRS-16N	CR-16N	15.6	20.0		200
CRS-19N	CR-19N	19.6	23.8		200
CRS-22N	CR-22N	22.5	27.0		100
CRS-24N	CR-24N	23.8	28.0		100
CRS-25N	CR-25N	25.2	30.0		100
CRS-28N	CR-28N	28.5	34.0		100



# Close-End Connector / 閉端端子

PRODUCTS DESCRIPTION		產品描述	
MATERIAL	UL Approved Nylon 6/6 Insulation	材質	採用UL合格之Nylon 6/6製成，防火等級UL94-V2，內部套管為銅管鍍錫或鋁合金
TERMINAL	Tin-plated copper or aluminum alloy	顏色	標準色為尼龍本色(白色)
TEMPERATURE RANGE	105 °C 300 Volts Max	特點	將電線外皮剝除後插入套管內用工具壓著即可

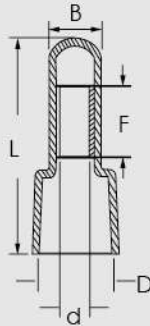

HW Type: Tin-plated copper  
CE Type : Aluminum alloy

## PRODUCTS SPECIFICATION 產品規格

線徑 WIRE RANGE AWG/mm <sup>2</sup>	型號 ITEM NO.	尺寸 DIMENSIONS inch (mm)				
		B	d	D	F	L
22~16 AWG 1.25 mm <sup>2</sup>	HW-C3	.197 (5.0)	.094 (2.4)	.268 (6.8)	.314 (8.0)	.713 (18.1)
16~14 AWG 2.0 mm <sup>2</sup>	HW-C4	.220 (5.6)	.118 (3.0)	.315 (8.0)	.354 (9.0)	.827 (21.0)
12~10 AWG 5.5 mm <sup>2</sup>	HW-C5	.280 (7.1)	.157 (4.0)	.413 (10.5)	.394 (10.0)	1.00 (25.5)
8 AWG 8.0mm <sup>2</sup>	HW-C8	.374 (9.5)	.189 (4.8)	.472 (12.0)	.433 (11.0)	1.09 (27.7)
22~16 AWG 1.25 mm <sup>2</sup>	CE-1	.197 (5.0)	.094 (2.4)	.244 (6.2)	.263 (6.7)	.713 (18.1)
16~14 AWG 2.0 mm <sup>2</sup>	CE-2	.220 (5.6)	.118 (3.0)	.311 (7.9)	.283 (7.2)	.787 (20.0)
12~10 AWG 5.5 mm <sup>2</sup>	CE-5	.287 (7.3)	.157 (4.0)	.413 (10.5)	.315 (8.0)	.996 (25.3)

## Screw-On Wire Nut / 彈簧螺式接頭

PRODUCTS DESCRIPTION		產品描述	
Material	Tough thermoplastic shell	材 質	熱可塑性工程塑料(膠殼)
Spring	Tough galvanized steel wire	彈 簧	高級鍍鋅鋼材，堅韌牢靠
Max. Temperature	105 °C / 150 °C	操作溫度	105 °C
Max. Voltage	300V / 600V	耐電壓值	300V / 600V
Flame-Retardant	UL94-V2	防火等級	UL-94V2
Easy for wire entrance and eliminates wire stands hang up. Apply for household appliance and lighting...ect.		特 點	適用於各種電器產品、燈飾及家庭配線等接線器材，可重複使用，安全可靠。

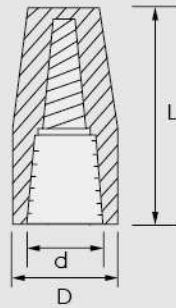

### PRODUCTS SPECIFICATION 產品規格

型號 ITEM NO.	線徑 WIRE RANGE	耐溫度 TEMP.	耐電壓 VOLTAGE	尺寸 DIMENSION			顏色 COLOR
				d(mm)	D(mm)	L(mm)	
E1	22~16AWG	105 °C	300V	6.0	8.5	14.7	Gray 
E2	22~14AWG	105 °C	300V	7.5	10.1	17.5	Blue 
E3	22~14AWG	105 °C	600V	8.2	11.2	21.4	Orange 
E4	18~12AWG	105 °C	600V	10.5	13.7	23.6	Yellow 
E5	18~10AWG	105 °C	600V	13.0	16	26.5	Red 
E11	22~16AWG	150 °C	300V	6.0	8.5	14.7	Black 
E21	22~14AWG	150 °C	300V	7.5	10.1	17.5	Black 

# Insulated Cord End Terminals / 歐式端子

DIN 46228 / 4

PRODUCTS DESCRIPTION		產品描述	
MATERIAL	Nylon	材質	採用UL合格之Nylon 6/6製成，防火等級94-V2，耐酸鹼、絕緣性良好、耐久性不易老化，內管為紅銅管鍍錫
TERMINAL	Copper Tube		
TEMPERATURE RANGE	-40 °C ~ 105 °C	額定溫度	-40 °C ~ 105 °C

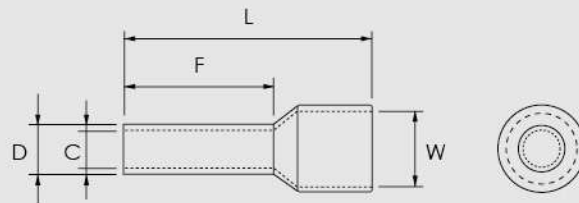

## PRODUCTS SPECIFICATION 產品規格

WIRE RANGE mm <sup>2</sup>	型號 ITEM NO.	尺寸 DIMENSIONS inch (mm)					顏色 COLOR SYSTEM		
		F	L	C	D	W	FRENCH	GERMAN	DIN
0.25	CE002506	.236(6.0)	.409 (10.4)	.031 (.80)	.043(1.1)	.075(1.9)	VIOLET	LIGHT BLUE	-
	CE002508	.315(8.0)	.488 (12.4)				PINK	TURQUOISE	-
0.34	CE003406	.236(6.0)	.409 (10.4)	.031 (.80)	.043(1.1)	.102(2.6)	WHITE	ORANGE	WHITE
	CE003408	.315(8.0)	.488 (12.4)				WHITE	ORANGE	WHITE
0.5	CE005006	.236(6.0)	.472 (12.0)	.039 (1.0)	.051(1.3)	.110(2.8)	BLUE	WHITE	GREY
	CE005008	.315(8.0)	.551 (14.0)				BLUE	WHITE	GREY
0.75	CE007506	.236(6.0)	.472 (12.0)	.047 (1.2)	.059(1.5)	.118(3.0)	RED	YELLOW	RED
	CE007508	.315(8.0)	.551 (14.0)				RED	YELLOW	RED
1.0	CE007510	.394(10.0)	.630 (16.0)	.055 (1.4)	.067(1.7)	.138(3.5)	BLACK	RED	BLACK
	CE007512	.472(12.0)	.709 (18.0)				BLACK	RED	BLACK
1.5	CE010006	.236(6.0)	.472 (12.0)	.067 (1.7)	.079(2.0)	.165(4.2)	GREY	BLUE	BLUE
	CE010008	.315(8.0)	.551 (14.0)				GREY	BLUE	BLUE
2.5	CE010010	.394(10.0)	.630 (16.0)	.087 (2.2)	.098(2.5)	.189(4.8)	ORANGE	GREY	GREY
	CE010012	.472(12.0)	.709 (18.0)				ORANGE	GREY	GREY
4.0	CE015008	.315(8.0)	.551 (14.0)	.110 (2.8)	.126(3.2)	.248(6.3)	GREEN	BLACK	YELLOW
	CE015010	.394(10.0)	.630 (16.0)				GREEN	BLACK	YELLOW
6.0	CE015012	.472(12.0)	.709 (18.0)	.138 (3.5)	.154(3.9)	.299(7.6)	BROWN	IVORY	RED
	CE015018	.709(18.0)	.945 (24.0)				BROWN	IVORY	RED
10	CE025008	.315(8.0)	.551 (14.0)	.177 (4.5)	.193(4.9)	.346(8.8)	IVORY	GREEN	BLUE
	CE025010	.394(10.0)	.685 (17.4)				IVORY	GREEN	BLUE
16	CE025012	.472(12.0)	.709 (18.0)	.228 (5.8)	.244(6.2)	.441(11.2)	BLACK	BROWN	YELLOW
	CE025018	.709(18.0)	.945 (24.0)				BLACK	BROWN	YELLOW
25	CE040010	.394(10.0)	.669 (17.0)	.287 (7.3)	.303(7.7)	.500(12.7)	RED	IVORY	RED
	CE040012	.472(12.0)	.787 (20.0)				RED	IVORY	RED
35	CE040018	.709(18.0)	1.024(26.0)	.327 (8.3)	.343(8.7)	.591(15.0)	BLUE	OLIVE	BLUE
	CE060012	.472(12.0)	.787 (20.0)				BLUE	OLIVE	BLUE
50	CE060018	.709(18.0)	1.024 (26.0)	.406(10.3)	.429(10.9)	.630(16.0)	YELLOW	YELLOW	YELLOW
	CE100012	.472(12.0)	.866 (22.0)				YELLOW	YELLOW	YELLOW
70	CE100018	.709(18.0)	1.102 (28.0)	.531(13.5)	.563(14.3)	.709(18.0)	RED	RED	RED
	CE160012	.472(12.0)	.945 (24.0)				RED	RED	RED
95	CE160018	.709(18.0)	1.102 (28.0)	.583(14.8)	.614(15.6)	.787(20.0)	BLUE	BLUE	BLUE
	CE250016	.630(16.0)	1.102 (28.0)				BLUE	BLUE	BLUE
120	CE250022	.866(22.0)	1.417 (36.0)	.657(16.7)	.697(17.7)	.906(23.0)	YELLOW	YELLOW	YELLOW
	CE350025	.984(25.0)	1.535 (39.0)				YELLOW	YELLOW	YELLOW
150	CE500020	.787(20.0)	1.417 (36.0)	.772(19.6)	.811(20.6)				
	CE500025	.984(25.0)	1.575 (40.0)						

## Splicing Connector / 快速接續子

PRODUCTS DESCRIPTION		產品描述	
MATERIAL	Solid Copper	材質	採用絕緣性及抗老化性佳的PC材質，內有防水膏以防止水氣浸蝕銅端子
INSULATION	PC / PP (UR2, UY2)	顏色	分別為紅色、黃色及藍色
Make a clean, solid and rapid connection of your wires to keep your communication lines free of noise. Also are available to handle a wide range of conductor sizes and allows you to handle higher pairs wire.		特點	免剝線即能使通信線路導通，同時達到UL Category 5 (網路線) 以上寬頻的傳輸效果



### PRODUCTS SPECIFICATION 產品規格

型號 ITEM NO.	最大線徑 Max Insulation OD (mm)	Application
UR	1.67	A two-or three-wire connection for Y type divergence wire of solid copper 0.9-0.4mm (19-26 AWG) wire core or 0.65-0.4mm (22-26 AWG) filled cable.
UY	1.52	A two-wire connector for solid copper 0.65-0.4mm(22-26 AWG) cable.
UB	1.27	A tap connector for T type divergence wire of solid copper 0.65-0.4mm (22-26 AWG) wire core or 0.5-0.4mm(24-26 AWG) filled core cable.
UR2	2.08	A two-or three-wire connector for Y type divergence wire of solid copper 0.9-0.4mm (19-26 AWG)
UY2	2.08	A two-wire connector for solid copper 0.9-0.4mm(19-26 AWG) wire cable.

## Quick Splicing / 接線夾

PRODUCTS DESCRIPTION		產品描述	
MATERIAL	Solid Copper	材質	銅端子+PP或Nylon外殼
INSULATION	PP or Nylon	顏色	紅色/黃色/藍色
Quick installation without stripping wire job, easy crimping with normal tool, Safety insulation tap		特點	免剝烏龜夾，縮短接線時間 接線工具簡單/快速 安全絕緣加蓋設計



### PRODUCTS SPECIFICATION 產品規格

型號 ITEM NO.	Wire Rang		Pole	Insulation	顏色 Color
	A.W.G.	mm2			
801-P3/P4	22-18	0.5-1.0	3/4	P.P.	Red <span style="color:red">■</span>
802-P3/P4	18-14	1.0-2.5	3/4	P.P.	Blue <span style="color:blue">■</span>
805-P3/P4	12-10	4.0-6.0	3/4	P.P.	Yellow <span style="color:yellow">■</span>
801-N3/N4	22-18	0.5-1.0	3/4	Nylon	Red <span style="color:red">■</span>
802-N3/N4	18-14	1.0-2.5	3/4	Nylon	Blue <span style="color:blue">■</span>
805-N3/N4	12-10	4.0-6.0	3/4	Nylon	Yellow <span style="color:yellow">■</span>

## Nylon Cable Tie Gun (Auto. Cut-off) / 尼龍束帶專用槍

PRODUCTS DESCRIPTION		產品描述	
MATERIAL	Metal	材質	高剛性金屬及耐磨耗刀頭
Auto Cut-off.		特點	適用於尼龍束帶寬度介於2.2mm~4.8mm 拉緊後自動剪斷
Nylon Cable Tie Widths From 2.2mm To 4.8mm.			



## Nylon Cable Tie Gun / 尼龍束帶專用槍

PRODUCTS DESCRIPTION		產品描述	
MATERIAL	Metal	材質	高剛性金屬及耐磨耗刀頭
Auto Cut-off.		特點	適用於尼龍束帶寬度介於3.6mm~13mm 拉緊後自動剪斷
Nylon Cable Tie Widths From 3.6mm To 13mm.			



## S. S Cable Tie Gun (Auto. Cut-off) / 全自動不銹鋼束帶專用槍

PRODUCTS DESCRIPTION		產品描述	
MATERIAL	Metal	材質	高剛性金屬及耐磨耗刀頭
Semiautomatic Cut-off		特點	適用於不銹鋼束帶寬度介於 4.6mm~7.9mm全自動拉緊切斷設計
S.S. Cable Tie Widths From 4.6mm To 7.9mm.			



## S. S Cable Tie Gun / 半自動不銹鋼束帶專用槍

PRODUCTS DESCRIPTION		產品描述	
MATERIAL	Metal	材質	高剛性金屬及耐磨耗刀頭
Semiautomatic Cut-off		特點	適用於不銹鋼束帶寬度介於 4.6mm~7.9mm半自動剪斷，手動拉緊 後，再拉刀片手把剪斷
S.S. Cable Tie Widths From 4.6mm To 7.9mm.			



# Professional Manufacturer\_TAIWAN

Nylon Parts / Plastic Fastener / OEM & ODM Service



## IDEAS TO SIMPLIFY WIRE & CABLE ARRANGEMENT



志信塑膠股份有限公司

JYH SHINN PLASTIC CO., LTD.



NO. 111, LANE 516, SEC.2 YIAN ROAD.,  
ANNAN DIST., TAINAN CITY, TAIWAN 70943

TEL : 886-6-2551788/2558209

FAX : 886-6-2558210

E-mail : jsp1976@ms71.hinet.net

Web : www.jsplastic.com

[www.fastener-world.com/en/supplier/jyh-shinn](http://www.fastener-world.com/en/supplier/jyh-shinn)



Taiwantrade  
Supplier  
Business  
Information  
Verification  
www.tivv.tw  
ID: 000067425







70943台南市安南區怡安路二段516巷111號  
No.111, Ln 516, Sec. 2, Yian Road, Annan Distr.,  
Tainan City, 70943 TAIWAN  
TEL:886-6-2551788 / 2558209 FAX: 886-6-2558210  
URL: [www.jsplastic.com](http://www.jsplastic.com) E-Mail:[jsp1976@ms71.hinet.net](mailto:jsp1976@ms71.hinet.net)